

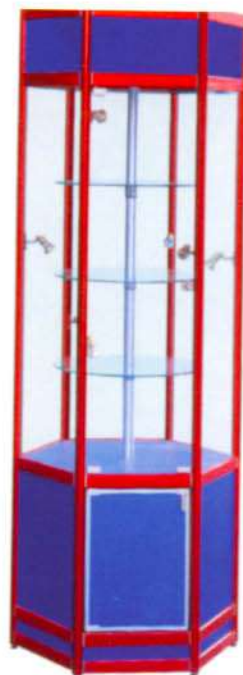

HB-138
1/4八棱柱墙角柜
1/4 8prism wall angel cabinet
Size: H1700xD1700xD400mm



HB-139
120度六角旋转饰柜
120° 6angel rolling ingenious cabinet
Size: H2080xD770mm



HB-140
3分方柱柜
3cm square prism cabinet
Size: H2100xD500xW500mm

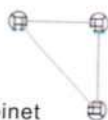

HB-142
90度圆柱墙角柜
90° Circle prism wall angel cabinet
Size: H1700xD400mm

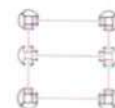

HB-151
90度圆柱背柜
90° Circle prism tergal cabinet
Size: H2060xD800xW400mm



HB-160
3分扇柱
3cm fan column
氧化原色: L6000mm

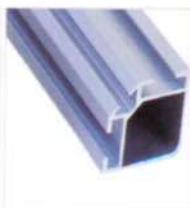
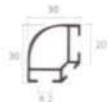

HB-161
3分角柱
3cm 90° column
氧化原色: L6000mm

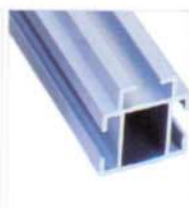
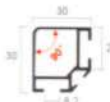

HB-162
3分三槽扁铝
3cm 3-groove
氧化原色: L6000mm

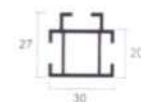

HB-163
3分四槽扁铝
3cm 4-groove
氧化原色: L6000mm

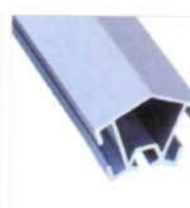
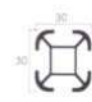

HB-164
3分120度角柱
3cm 120° column
氧化原色: L6000mm



HB-165
3分135度角柱
3cm 135° column
氧化原色: L6000mm

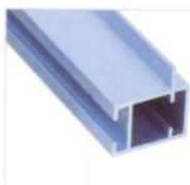

HB-166
3分单槽单筋扁铝
3cm single groove
氧化原色: L6000mm

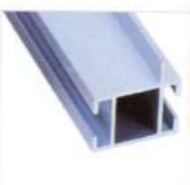
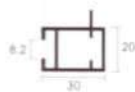

HB-167
3分2槽单筋扁铝
3cm 2-groove
氧化原色: L6000mm

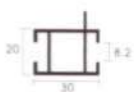

HB-168
3分2槽双筋扁铝
3cm 2-groove
氧化原色: L6000mm

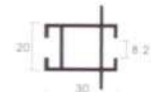

HB-169
3分2槽扁铝
3cm 2-groove
氧化原色: L6000mm

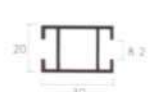

HB-170
胶山槽
Plastic up track
氧化原色: L6000mm



HB-171
胶山槽
Plastic bottom track
氧化原色: L6000mm



HB-172
二槽圆柱
2-Groove column
砂银: L2100mm 金色: 2400mm



HB-173
120度圆柱
2-Groove 120° column
砂银: L2100mm 金色: 2400mm



HB-174
135度圆柱
2-Groove 135° column
砂银: L2100mm 金色: 2400mm



HB-175
三槽圆柱
3-Groove column
砂银: L2100mm 金色: 2400mm

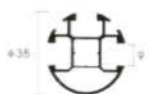

HB-176
单筋双槽扁铝
2-Groove single side pipe
砂银、金色: L3000mm



HB-177
单筋单槽扁铝
Single-Groove single side pipe
砂银、金色: L3000mm

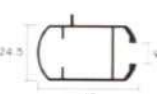

HB-178
单筋单槽扁材
single-groove single side pipe
砂银、金色: L3000mm

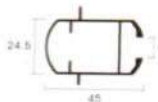

HB-179
双筋双槽扁材
Double-groove single side pipe
砂银、金色: L3000mm

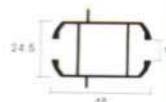

HB-180
四槽圆柱
4-Groove column
砂银: L2100mm 金色: L2400mm

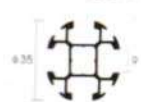

HB-181
多变柱
Great functional column
砂银: L2100mm 金色: L2400mm

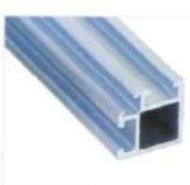

HB-182
2分角柱
2cm 90° column
氧化原色: L6000mm

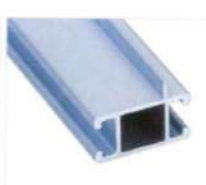

HB-183
2分单筋双槽
2cm 2-groove column
氧化原色: L6000mm

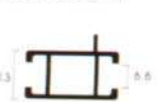

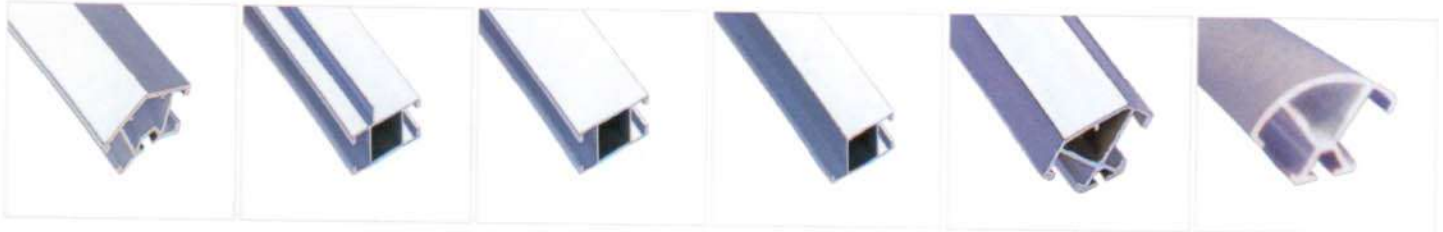

HB-184
135度屋形
135° House type cabinet frame
半月光、金色: L3000mm

HB-185
五脚材
Five leg cabinet frame
半月光、金色: L3000mm

HB-186
四脚材
Three leg cabinet frame
半月光、金色: L3000mm

HB-187
三脚材
Four leg cabinet frame
半月光、金色: L3000mm

HB-188
102角
102 cabinet frame
半月光、金色: L3000mm

HB-189
208分大扇形
28mm sector column
氧化原色: L6000mm

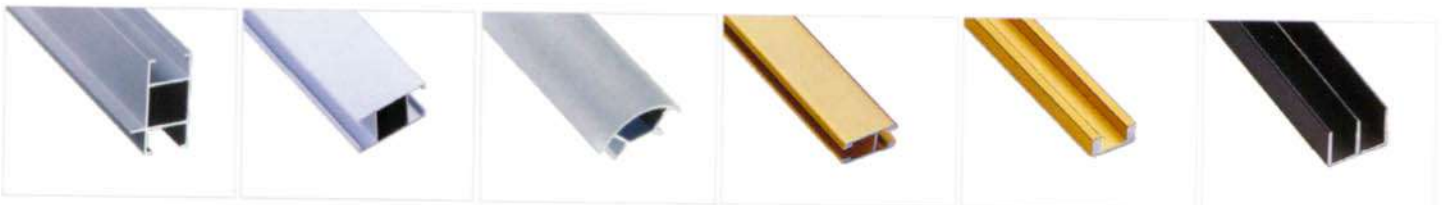
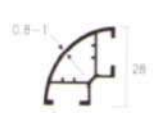
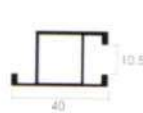
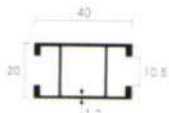
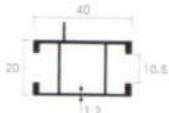

HB-190
地柜层板
28mm sector column
氧化原色: L6000mm

HB-191
地柜中柱
Cabinet mid column
氧化原色: L6000mm

HB-192
1.8分康柱
18mm sector column
氧化原色: L6000mm

HB-193
5mm H槽
5mm H type groove
氧化原色: L6000mm
砂银/金色: L3000mm

HB-194
低槽 (金色)
Bottom groove (Gold)
氧化原色: L6000mm
砂银/金色: L3000mm

HB-195
山槽 (黑色)
Plastic up track (Black)
氧化原色: L6000mm
黑色/砂银/金色: L3000mm

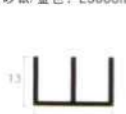
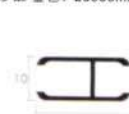
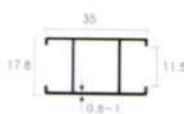
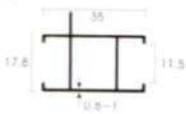

HB-196
砂银圆柱柜门侧修边
Decorative cabinet edge
氧化原色: L6000mm
砂银/金色: L3000mm

HB-197
山槽 (带脚)
Mount type track
砂银/金色: L3000mm

HB-198
低槽 (带脚)
Track
砂银/金色: L3000mm

HB-199
盖材 (砂银)
Cover (Silver color)
砂银/金色: L3000mm

HB-200
8mm 玻璃门夹
8mm Glass door clip

HB-202
盖材
Cabinet frame cover
砂银/金色: L3000mm

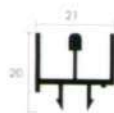
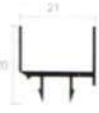

HB-203
102角山槽 (黑色)
102 Angel groove
黑色: L3000mm

HB-204
102角山槽 (黑色)
102 Angel groove
黑色: L3000mm

哑光金色
Gold

红色
Red

金色
Gold

砂银
Silver

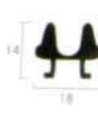
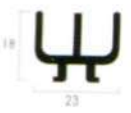

黑色
Black

亮光
Gloss (Stainless steel)

氧化原色
Oxidation





HB-205
三叉接角 (电镀铝)
Aluminum end cover



HB-206
三叉接角 (塑料)
Plastic end cover



HB-207
三叉接角 (电镀铝)
Aluminum 102 cabinet
end cover



HB-208
大扇形三叉
Big sector type end cover



HB-209
小扇形三叉
Small sector type end cover



HB-210
直驳 (工程塑料)
PVC connector fitting



HB-211
圆柱柜直驳 (工程塑料)
Connector fitting



HB-212
饰柜层板托
Shelf holder



HB-213
三角头螺丝
Screw
HB-214
玻璃垫片
Shelf



HB-215
金色牛眼灯
Cabinet light power: 20w



HB-216
射灯
Cabinet light
HB-217
石英射灯
Quartz Lamp



HB-218
可逆永磁同步电机
Quartz Lamp



HB-219
50mm, 30mm圆管
50mm, 38mm tube



HB-220
两极扁脚插头
Plug



HB-221
电子变压器
Transformer



可承重30Kg

HB-222
可逆永磁同步电机
Motor



HB-223
轴承
Axletree



HB-224
50, 38转轴玻璃托 (法兰)
Flante



HB-225
掩门铰
Hinge



HB-226
单磁吸
Magnetic door stopper
HB-227
双磁吸



HB-228
玻璃掩门锁
Glass door lock (single)



HB-229
玻璃掩门锁 (双门)
Glass door lock (double door)



HB-230
H路趟门锁
Slid door lock



HB-231
玻璃趟门锁
Glass door lock



HB-232
饰柜趟轮
Slide wheel



HB-233
饰柜趟轮
Slide wheel



HB-234
饰柜趟轮
Slide wheel



HB-235
饰柜趟轮
Slide wheel



HB-236
玻璃趟轮
Slide wheel



HB-237
H路轴 (承轴) H路轮 (铁)
H type wheel H type wheel



HB-238
圆柱柜调节脚
Leg (Adjust)



HB-239
拉母
HB-240
左右码
Connector fitting

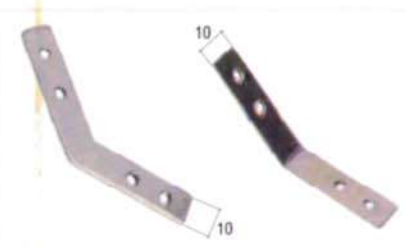

HB-241
135° 平角码
Connector fitting

HB-242
135° 曲角码
Connector fitting

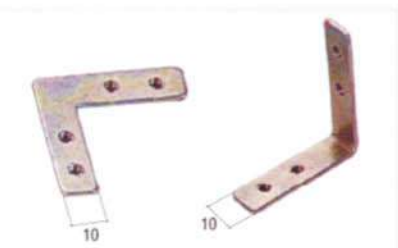

HB-243
90° 平角码
Connector fitting

HB-244
90° 曲角码
Connector fitting



HB-245
挂钩托码
Bracket rails



HB-246
3分柜料胶条
(4mm)



HB-247
3分柜料胶条
(4mm)



HB-248
102角胶条
(4mm)



HB-259
102角透明胶条
(4mm)



HB-250
Aa柱
Bracket rails



HB-251
102角胶条
(5mm)



HB-252
圆柱透明胶条
(4mm)



HB-253
圆柱透明胶条
(5mm)



HB-254
大扇形胶条



HB-255
冲孔板专用挂钩 (短)
Hook

HB-256
冲孔板专用挂钩 (长)
Hook



HB-257
3分角柱封口盖
3cm end cover



HB-258
3分扇形封口盖
3cm end cover



HB-259
3分三槽封口盖
3cm end cover



HB-260
3分方柱封口盖
3cm end cover



HB-261
圆柱封口盖
End cover



HB-262
102角封口盖
102Column end cover



HB-263
2分角柱封口盖
2cm end cover



HB-264
3分二槽封口盖
3cm end cover



HB-328
玻璃爪 (单爪)
Glass/panel vetainer

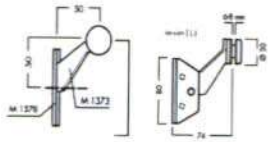

HB-329
玻璃爪 (两爪)
Glass/panel vetainer

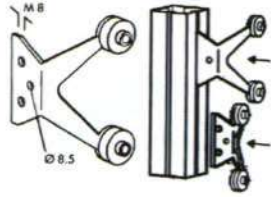

HB-330
玻璃爪 (三爪)
Glass/panel vetainer

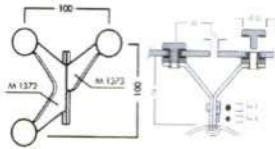

HB-331
玻璃爪 (四爪)
Glass/panel vetainer

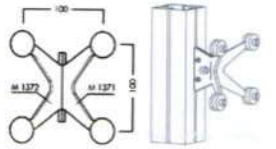

HB-332
单点玻璃爪
Glass/panel vetainer

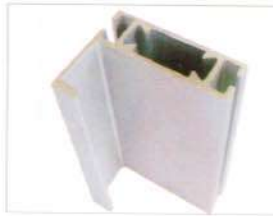
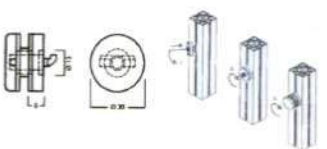

HB-333
单面墙型材
Beam Extrusion
Length: 6m

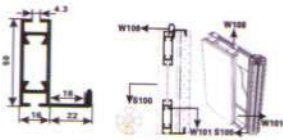

HB-334
双面墙型材
Beam Extrusion
Length: 6m

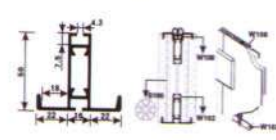

HB-335
顶部构件
Top panel retainer

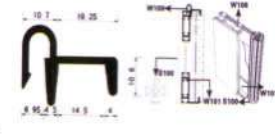

HB-336
全封板
All-sealed panel

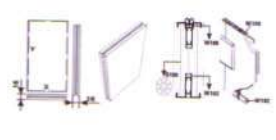

HB-337
中间用托件
Panel retainer for
horizontal grooves

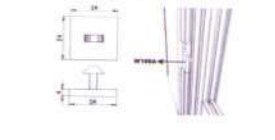

HB-338
十字铝
Separate from panels
Length: 6m

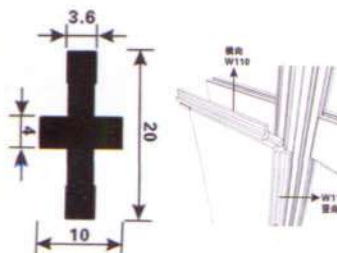

HB-339
工字铝
Extrusion connector
Length: 6m

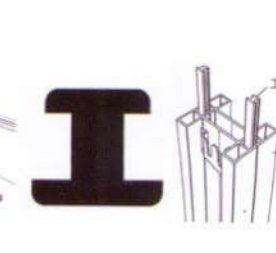

HB-340
棘轮梅花扳手
Ratchet with torx
head



HB-341
压板件
Press plate

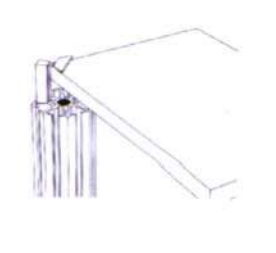

HB-342
钩头螺栓
Bolt





HB-343

HB-344

HB-345

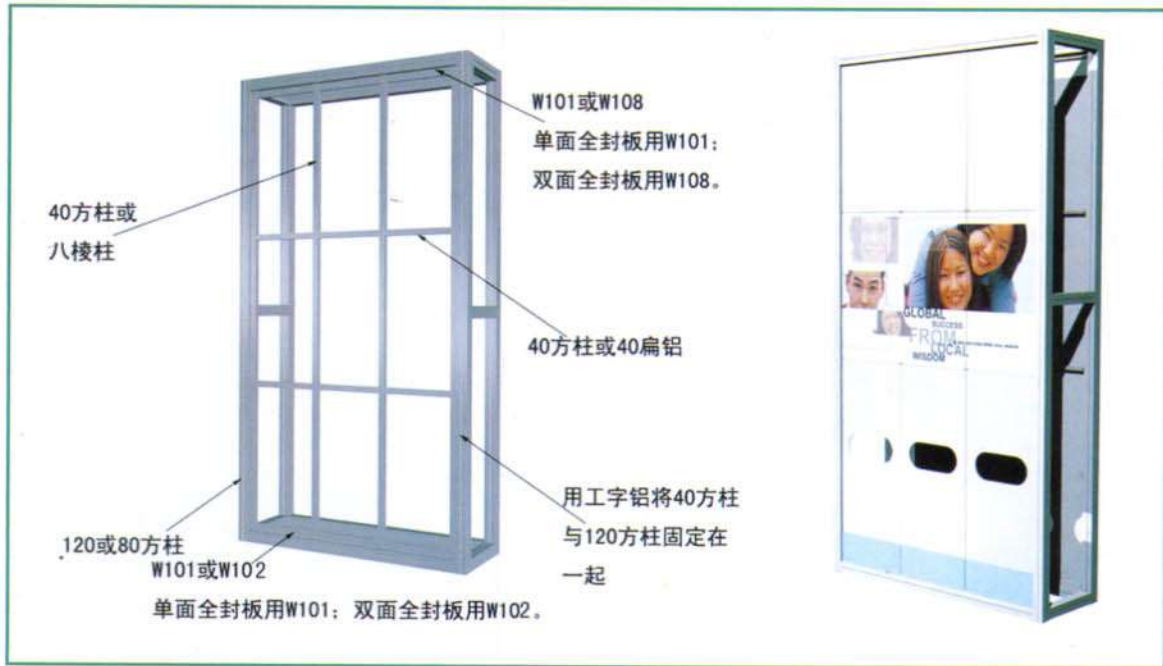
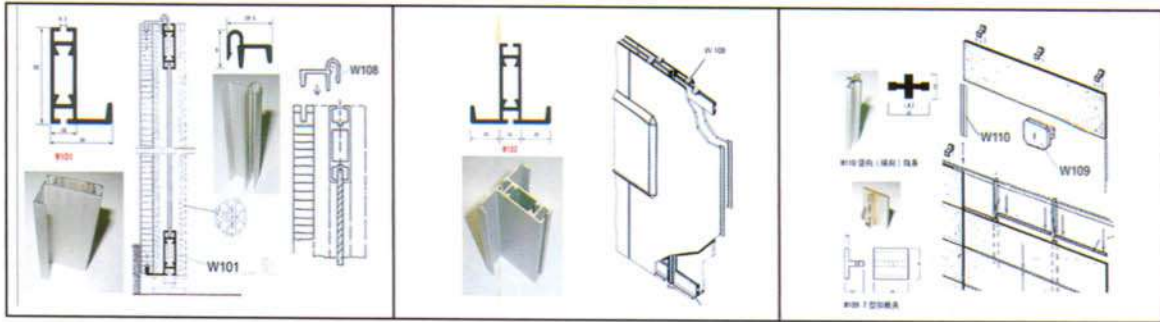

HB-346
20画框
Frame extrusion/20
Lenght:6m

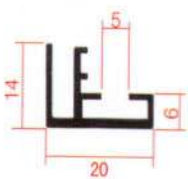

HB-347
40单面弹力布边框
Single-sided frame
Lenght:6m

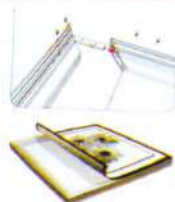
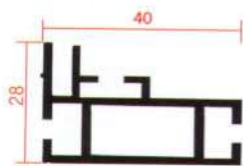

HB-348
40双面弹力布边框
Single-sided frame
Lenght:6m

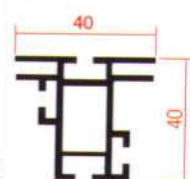

HB-349
40弹力布边框
Frame extrusion
Lenght:6m

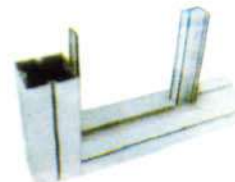
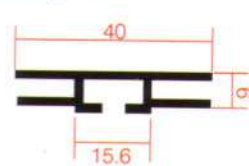

HB-350
80双面弹力布边框
Double-sided frame
Lenght:6m

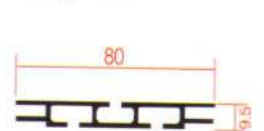



HB-351



HB-352



HB-353





01

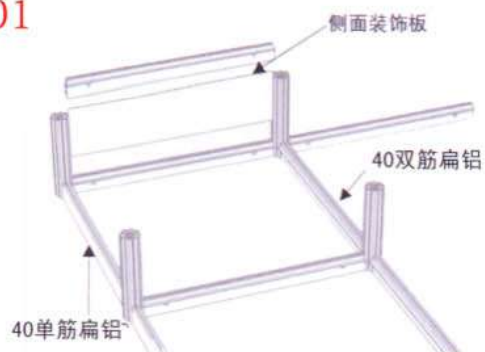

首先放置好八棱柱，分别锁上地台的下横梁，然后再装上侧面装饰板，锁好上横梁。

02

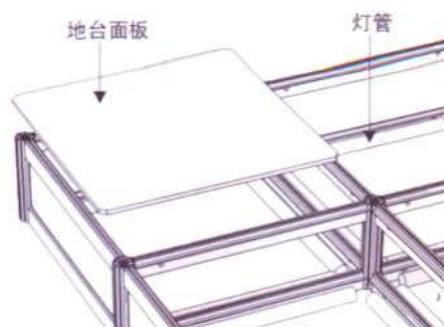

地台主框架搭好后，开始布线，装灯管，最后铺地台面板。

03

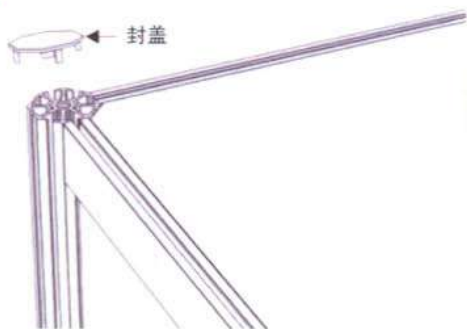

地台面板铺装完成后，装上八通立柱封盖。

04



安装完成后的地台示样。





HB-354
右齿轮转柱
Right fold round
too extrusion
Length: 6m

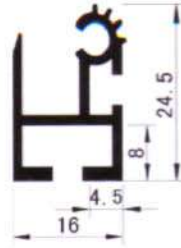

HB-355
左齿轮转柱
Left fold round
too extrusion
Length: 6m

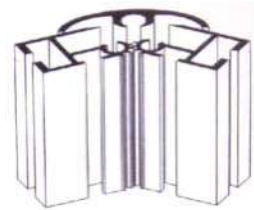

HB-356
圆弧转柱
Fold arc extrusion
Length: 6m

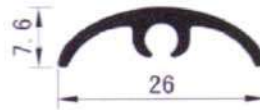

HB-357
移门滑槽
Runner frame extrusion
Length: 6m

